

## **PWM Control 3.5A Step-Down Converter**

### ❖ GENERAL DESCRIPTION

AX4102 consists of step-down switching regulator with PWM control. These device include a reference voltage source, oscillation circuit, error amplifier, internal PMOS and etc.

AX4102 provides low-ripple power, high efficiency, and excellent transient characteristics. The PWM control circuit is able to the duty ratio linearly form 0 up to 100%. An enable function, an over current protect function and short circuit protect function are built inside, and when OCP or SCP happens, the operation frequency will be reduced. Also, an internal compensation block is built in to minimum external component count.

With the addition of an internal P-channel Power MOS, a coil, capacitors, and a diode connected externally, these ICs can function as step-down switching regulators. They serve as ideal power supply units for portable devices when coupled with the SOP-8L package, providing such outstanding features as low current consumption. Since this converter can accommodate an input voltage up to 23V, it is also suitable for the operation via an AC adapter.

### ❖ FEATURES

- Input voltage : 3.6V to 23V
- Output voltage : 0.8V to  $V_{CC}$
- Duty ratio : 0% to 100% PWM control
- Oscillation frequency : 330KHz typ.
- Current Limit (CL), Enable function.
- Thermal Shutdown function.
- Short Circuit Protect (SCP).
- Built-in internal SW P-channel MOS.
- SOP-8L Pb-Free package.



**❖ ABSOLUTE MAXIMUM RATINGS** (at  $T_A=25^{\circ}\text{C}$ )

Characteristics	Symbol	Rating	Unit
VCC Pin Voltage	$V_{CC}$	$V_{SS} - 0.3$ to $V_{SS} + 25$	V
Feedback Pin Voltage	$V_{FB}$	$V_{SS} - 0.3$ to $V_{CC}$	V
ON/OFF Pin Voltage	$V_{EN}$	$V_{SS} - 0.3$ to $V_{CC} + 0.3$	V
Switch Pin Voltage	$V_{SW}$	$V_{SS} - 0.3$ to $V_{CC} + 0.3$	V
Power Dissipation	PD	Internally limited	mW
Storage Temperature Range	$T_{ST}$	-40 to +150	$^{\circ}\text{C}$
Operating Junction Temperature Range	$T_J$	-20 to +125	$^{\circ}\text{C}$
Operating Supply Voltage	$V_{OP}$	+3.6 to +23	V
Output Current	$I_{OUT}$	0 to 3.5	A
Peak Current	$I_{Peak}$	6.0	A
Thermal Resistance from Junction to case	$\theta_{JC}$	25	$^{\circ}\text{C/W}$
Thermal Resistance from Junction to ambient	$\theta_{JA}$	70	$^{\circ}\text{C/W}$

Note :  $\theta_{JA}$  is measured with the PCB copper area(need connect to SW pins) of approximately 1 in<sup>2</sup>(Multi-layer).

**❖ ELECTRICAL CHARACTERISTICS**

( $V_{IN} = 12\text{V}$ ,  $V_{OUT}=3.3\text{V}$ ,  $T_A=25^{\circ}\text{C}$ , unless otherwise specified)

Characteristics	Symbol	Conditions	Min	Typ	Max	Units
Feedback Voltage	$V_{FB}$	$I_{OUT}=0.1\text{A}$	0.784	0.8	0.816	V
Quiescent Current	$I_{CCQ}$	$V_{FB}=1.2\text{V}$ force driver off	-	3	5	mA
Feedback Bias Current	$I_{FB}$	$I_{OUT}=0.1\text{A}$	-	0.1	0.5	$\mu\text{A}$
Shutdown Supply Current	$I_{SD}$	$V_{EN} = 0\text{V}$	-	2	10	$\mu\text{A}$
OCSET pin bias current	$I_{OCSET}$		110	130	150	$\mu\text{A}$
Switch Current	$I_{SW}$		4.5	-	-	A
Line Regulation	$\Delta V_{OUT}/V_{OUT}$	$V_{CC} = 8\text{V}\sim 23\text{V}$ , $I_{OUT}=0.2\text{A}$	-	1	2	%
Load Regulation	$\Delta V_{OUT}/V_{OUT}$	$I_{OUT} = 0.1$ to $3.5\text{A}$	-	0.2	0.5	%
Oscillation Frequency	$F_{OSC}$	SW pin	260	330	400	KHz
EN Pin Logic input threshold voltage	$V_{SH}$	High (regulator ON)	2.0	-	-	V
	$V_{SL}$	Low (regulator OFF)	-	-	0.8	
EN Pin Input Current	$I_{SH}$	$V_{EN}=2.5\text{V}$ (ON)	-	20	-	$\mu\text{A}$
	$I_{SL}$	$V_{EN}=0.3\text{V}$ (OFF)	-	-10	-	$\mu\text{A}$
Internal MOSFET $R_{DS(ON)}$	$R_{DS(ON)}$	$V_{CC}=5\text{V}$ , $V_{FB}=0\text{V}$	-	80	140	m $\Omega$
		$V_{CC}=12\text{V}$ , $V_{FB}=0\text{V}$	-	55	90	
Efficiency	EFFI	$V_{CC}=12\text{V}$ , $V_{OUT} = 5\text{V}$	$I_{OUT} = 2\text{A}$	-	92	%
			$I_{OUT} = 3.5\text{A}$	-	90	

❖ APPLICATION CIRCUIT

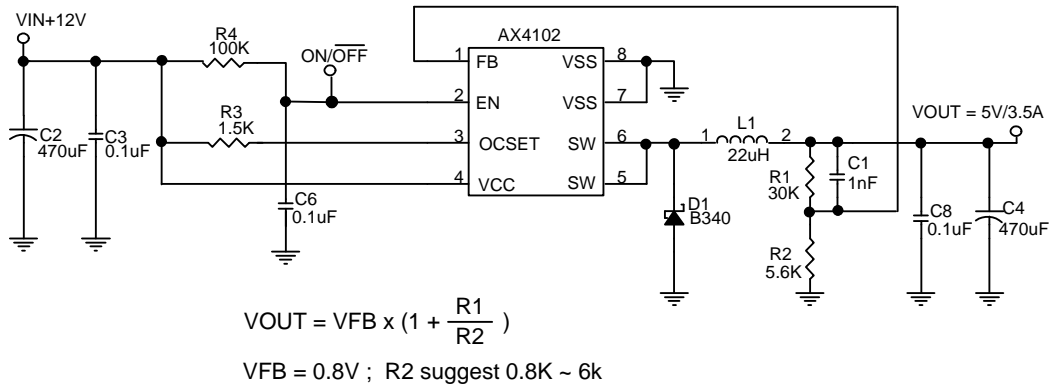

L1 recommend value (VIN=12V)				
V <sub>OUT</sub>	1.8 V	2.5V	3.3V	5V
I <sub>OUT</sub> =3.5A	12uH	15uH	18uH	22uH

❖ FUNCTION DESCRIPTIONS

PWM Control

The AX4102 consists of DC/DC converters that employ a pulse-width modulation (PWM) system. In converters of the AX4102, the pulse width varies in a range from 0 to 100%, according to the load current. The ripple voltage produced by the switching can easily be removed through a filter because the switching frequency remains constant. Therefore, these converters provide a low-ripple power over broad ranges of input voltage and load current.

RDS (ON) Current Limiting

The current limit threshold is setting by the external resistor (R3) connecting from V<sub>CC</sub> supply to OCSET pin. The internal 130uA sink current crossing the resistor sets the voltage at pin of OCSET. When the PWM voltage is less than the voltage at OCSET, an over-current condition is triggered. Please refer to the formula for setting the current limit value:

$$I_{SW(MIN)} = \frac{I_{OCSET} \times R3 + 0.08}{R_{DS(ON)}}$$

(Normally, The I<sub>SW(MAX)</sub> setting more than I<sub>OUT</sub> 1.0A ).

Example:

$$I_{SW} = (0.13mA \times 1.5K + 0.08) / 0.055 = 5A \quad (V_{IN}=12V)$$

$$I_{SW} = (0.13mA \times 2.7K + 0.08) / 0.080 = 5.39A \quad (V_{IN}=5V)$$

### Setting the Output Voltage

Application circuit item shows the basic application circuit with AX4102 adjustable output version. The external resistor sets the output voltage according to the following equation:

$$V_{OUT} = 0.8V \times \left(1 + \frac{R1}{R2}\right)$$

Table 1 Resistor select for output voltage setting

V <sub>OUT</sub>	R2	R1
5V	1.3K	6.8K
	5.6K	30K
3.3V	1.5K	4.7K
	5.6K	18K
2.5V	2.2K	4.7K
	5.6K	12K
1.8V	2K	2.5K
1.5V	2.2K	2.0K
1.2V	3K	1.5K
1.0V	3K	0.75K

R2 setting 5.6k that System Operation Current (No load) can be reducing to under 4mA.

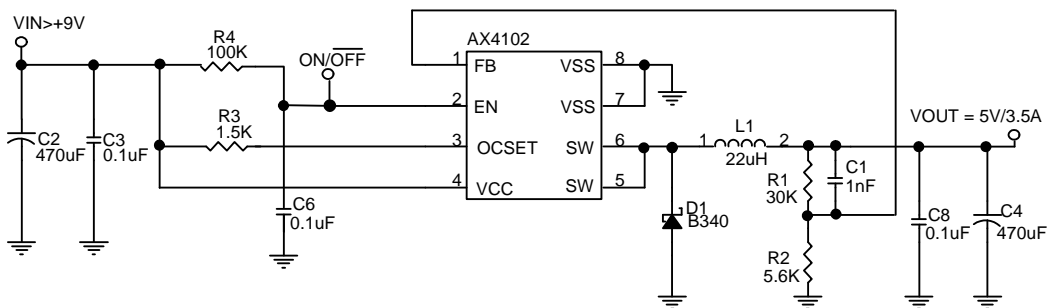

### PCB Layout Guide

If you need low Tc and Tj or large PD (Power Dissipation), the dual SW pins (5 and 6) on the SOP-8L package are internally connected to die pad, The PCB layout should allow for maximum possible copper area at the SW pins.

1. Connect C3 to V<sub>CC</sub> pin as closely as possible to get good power filter effect.
2. Connect R3 to V<sub>CC</sub> pin as closely as possible.
3. Connect ground side of the C2 and D1 as closely as possible.

❖ TYPICAL CHARACTERISTICS

VFB VS VIN

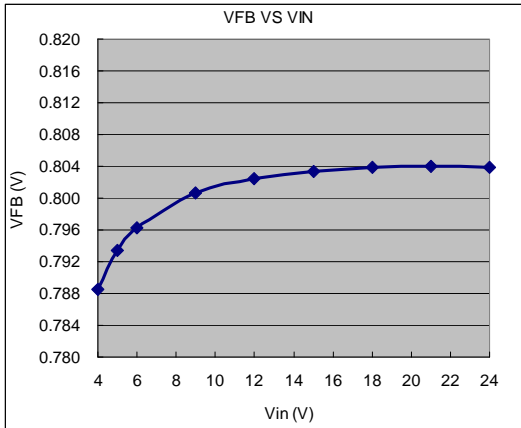

ICCQ VS VIN

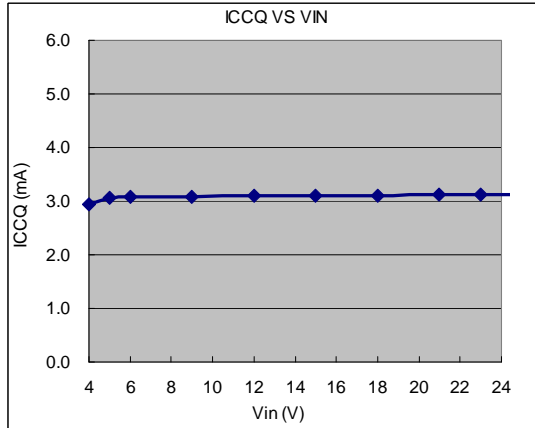

FOSC VS VIN

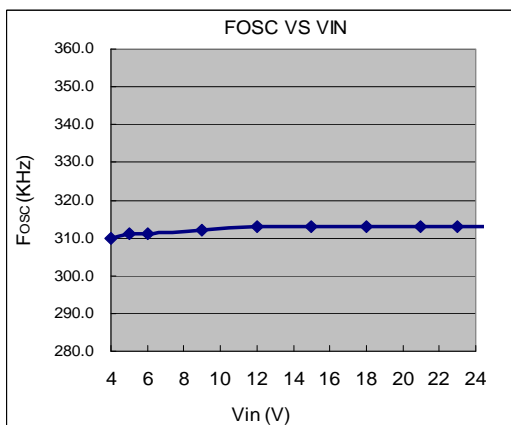

FOSC VS TEMPERATURE

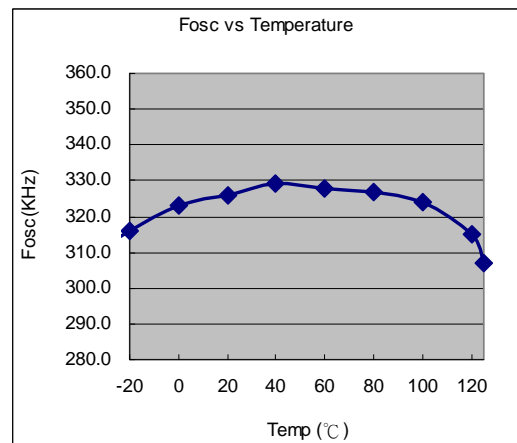

VFB VS TEMPERATURE

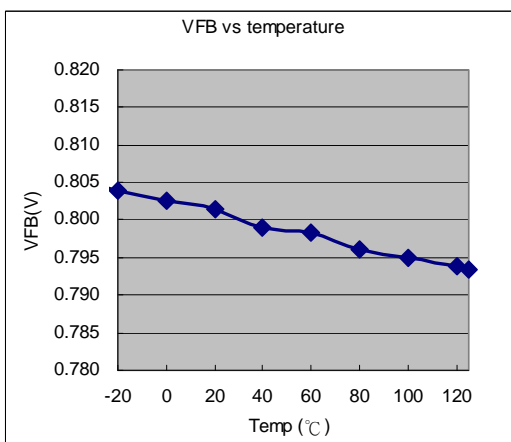

ICCQ VS TEMPERATURE

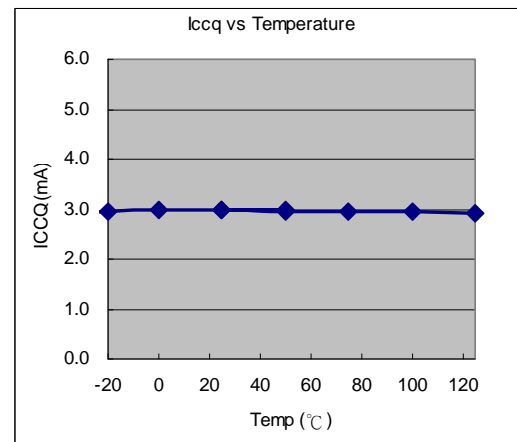

❖ TYPICAL CHARACTERISTICS (CONTINUES)

Output Ripple  
( $V_{IN}=12V, V_{OUT}=5V, I_{OUT}=3A$ )

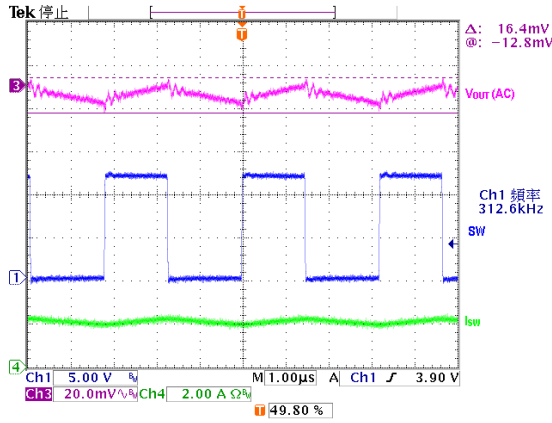

Power on test wave  
( $V_{IN}=12V, V_{OUT}=5V, I_{OUT}=3A$ )

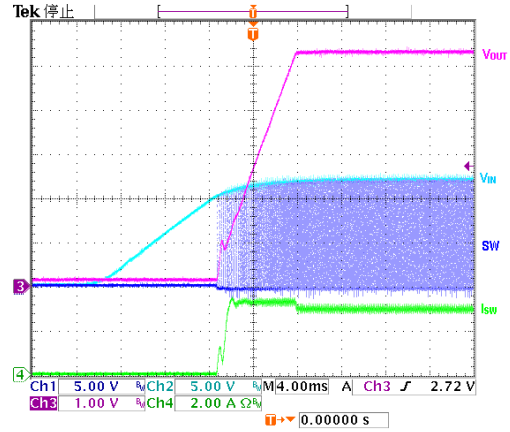

Load Transient Response  
( $V_{IN}=12V, V_{OUT}=5V, I_{OUT}=0.1\sim 3A$ )

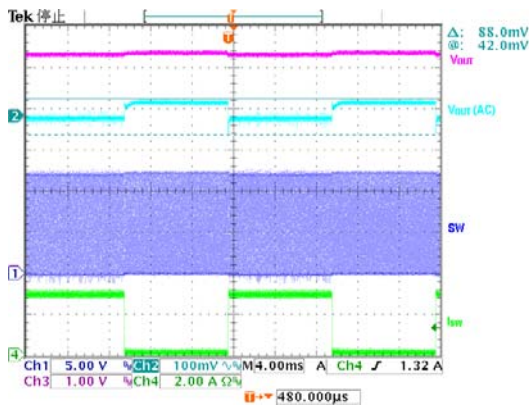

EN PIN on test wave  
( $V_{IN}=12V, V_{OUT}=5V, I_{OUT}=3A$ )

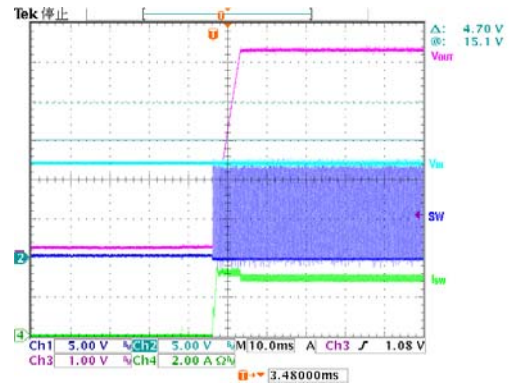

Efficiency  
( $V_{IN}=12V, V_{OUT}=5V$ )

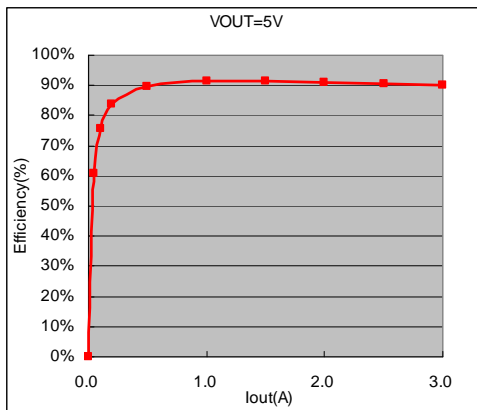

Efficiency  
( $V_{IN}=12V, V_{OUT}=3.3V$ )

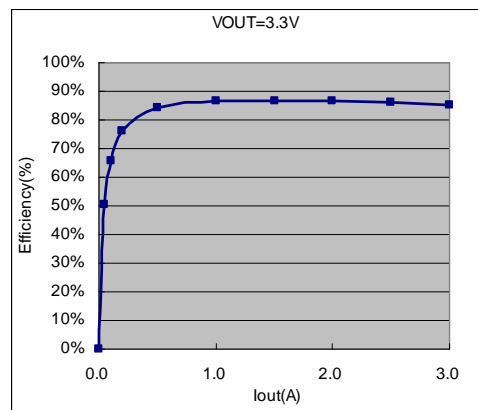

❖ PACKAGE OUTLINES

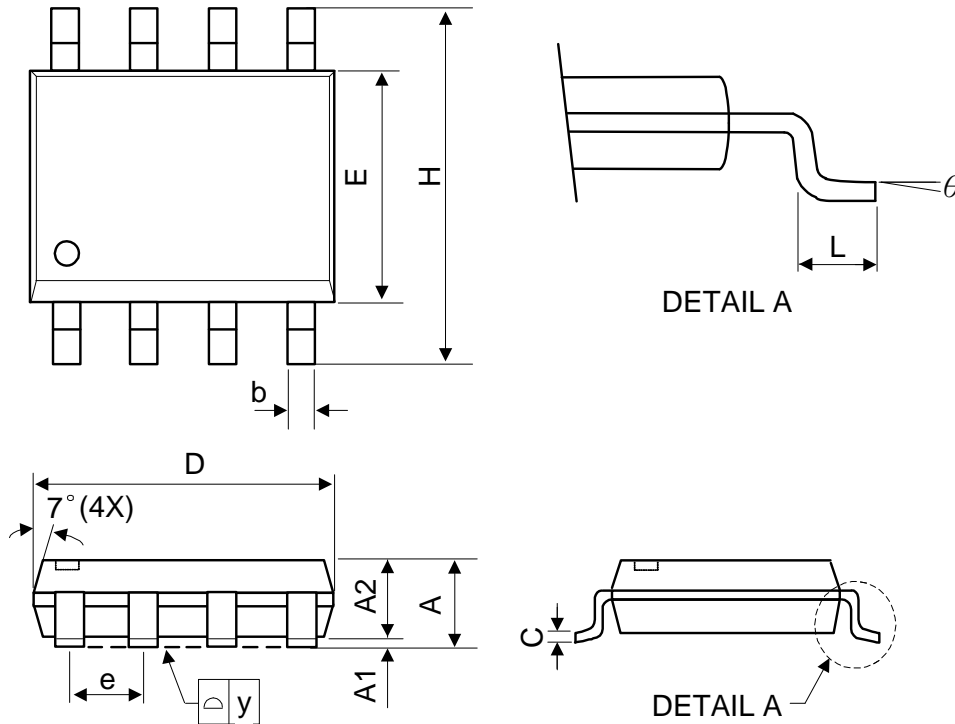

Symbol	Dimensions in Millimeters			Dimensions in Inches		
	Min.	Nom.	Max.	Min.	Nom.	Max.
A	-	-	1.75	-	-	0.069
A1	0.1	-	0.25	0.04	-	0.1
A2	1.25	-	-	0.049	-	-
C	0.1	0.2	0.25	0.0075	0.008	0.01
D	4.7	4.9	5.1	0.185	0.193	0.2
E	3.7	3.9	4.1	0.146	0.154	0.161
H	5.8	6	6.2	0.228	0.236	0.244
L	0.4	-	1.27	0.015	-	0.05
b	0.31	0.41	0.51	0.012	0.016	0.02
e	1.27 BSC			0.050 BSC		
y	-	-	0.1	-	-	0.004
θ	0°	-	8°	0°	-	8°

Mold flash shall not exceed 0.25mm per side

JEDEC outline: MS-012 AA